

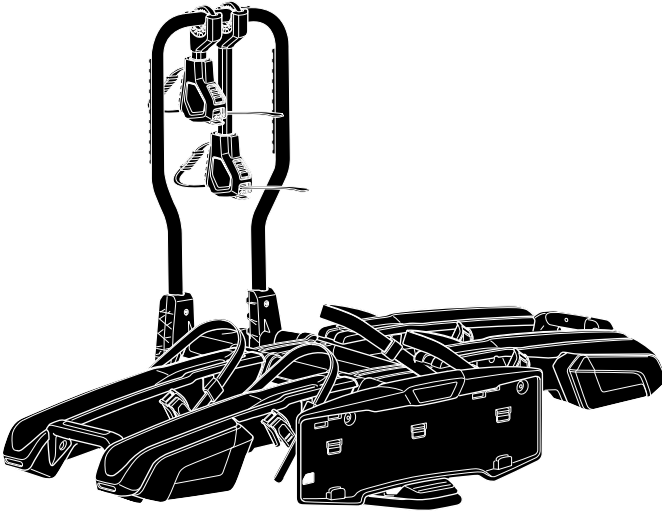

➤ Instructions

Thule EasyFold 3 2-bike 9441, 9442





IMPORTANT - READ THE INSTRUCTIONS CAREFULLY BEFORE USE AND KEEP FOR FUTURE REFERENCE.

Visual Language

 **WARNING** indicates a hazardous situation which, if not avoided, could result in death or serious injury.

 **Note** indicates additional information that is useful for trouble-free and optimal use of the product.

 Visual check **OK**

 Visual check **Not OK**

 Audible click

IMPORTANT - LISEZ ATTENTIVEMENT CES INSTRUCTIONS ET CONSERVEZ-LES POUR RÉFÉRENCE FUTURE.

Symboles

 **AVERTISSEMENT** indique une situation potentiellement dangereuse qui, si elle n'est pas évitée, pourrait provoquer des blessures graves, voire mortelles.

 **REMARQUE** indique comment répondre à une situation donnée et vous donnent des conseils sur le fonctionnement des options disponibles.

 Inspection visuelle **OK**

 Inspection visuelle **Pas OK**

 Clic audible

IMPORTANTE - LEER LAS INSTRUCCIONES CUIDADOSAMENTE ANTES DEL USO Y MANTENERLAS PARA FUTURAS CONSULTAS.

Lenguaje visual

 **ADVERTENCIA** Indica una situación de posible peligro que, si no se evita, podría provocar lesiones graves o incluso la muerte.

 **NOTA** Indica información adicional que es útil para un uso óptimo y sin problemas del producto.

 Comprobación visual **OK**

 Comprobación visual **No OK**

 Clic audible

WICHTIG - LESEN SIE DIESE ANLEITUNG SORGFÄLTIG DURCH UND BEWAHREN SIE ZUM NACHSCHLAGEN AUF.

Bildsprache

 **WARNUNG:** Eine mögliche Gefahrensituation, die, wenn sie nicht vermieden wird, zum Tod oder zu ernsthaften Verletzungen führen kann.

 **HINWEIS:** Eine zusätzliche Information, die für eine problemlose und optimale Verwendung des Produkts nützlich ist.

 Sichtprüfung **OK**

 Sichtprüfung **Nicht OK**

 Hörbares Klicken

BELANGRIJK - LEES DE GEBRUIKSAANWIJZING ZORGVULDIG DOOR EN BEWAAR DEZE VOOR LATER GEBRUIK.

Visuele taal



WAARSCHUWING duidt op een gevaarlijke situatie die, indien deze niet wordt vermeden, de dood of ernstig letsel tot gevolg kan hebben.



OPMERKING geeft aanvullende informatie aan die nuttig is voor een probleemloos en optimaal gebruik van het product.



Visuele controle **OK**



Visuele controle **Niet OK**



Hoorbare klik

IMPORTANTE - LEGGERE ATTENTAMENTE LE ISTRUZIONI PRIMA DELL'USO E CONSERVARLE PER FUTURO RIFERIMENTO.

Linguaggio visivo



AVVERTIMENTO: indica una situazione pericolosa che, se non evitata, potrebbe causare la morte o gravi lesioni.



NOTA indica informazioni aggiuntive utili per un utilizzo senza problemi e ottimali del prodotto.



Controllo visivo **OK**



Controllo visivo **Non OK**



Clic percettibile

IMPORTANTE - LER CUIDADOSAMENTE AS INSTRUÇÕES ANTES DE USAR E GUARDÁ-LAS PARA FUTURA REFERÊNCIA.

Informações visuais



ATENÇÃO indica uma situação perigosa que, se não for evitada, pode resultar em morte ou ferimentos graves.



NOTA indica informações adicionais que são úteis para a utilização ideal e sem problemas do produto.



Verificação visual: **OK**



Verificação visual: **Não OK**



Clique audível

VIKTIGT - LÄS INSTRUKTIONERNA NOGGRANT OCH SPARA FÖR FRAMTIDA REFERENS.

Visuella instruktioner



VARNING! Indikerar en potentiellt farlig situation som, om den inte undviks, kan leda till dödsfall eller allvarlig personskada.



OBS! Indikerar ytterligare information som är användbar för problemfri och optimal användning av produkten.



Visuell kontroll **OK**



Visuell kontroll **Inte OK**



Hörbart klick

VIGTIGT - LÆS OMHYGGELIGT.
GEM TIL FREMTIDIG BRUG.

Visualiser sprog



ADVARSEL angiver en potentielt farlig situation, som, hvis den ikke undgås, kan føre til død eller alvorlig skade.



BEMÆRK angiver yderligere information, der er nyttig for problemfri og optimal brug af produktet.



Visuelt tjek - **OK**



Visuelt tjek - **Ikke OK**



Hørbart klik

VIKTIG - TA VARE PÅ DISSE INSTRUKSJONENE, DU KAN FÅ BEHOV FOR DEM SENERE.

Symboler



ADVARSEL indikerer en potensielt farlig situasjon som, hvis den ikke unngås, kan føre til død eller alvorlig personskade.



MERK indikerer tilleggsinformasjon som er nyttig for problemfri og optimal bruk av produktet.



Visuell sjekk - **OK**



Visuell sjekk - **Ikke OK**



Hørbart klikk

TÄRKEÄ - LUE OHJEET HUOLELLISESTI ENNEN KÄYTTÖÄ JA SÄILYLTÄ NE TULEVAA KÄYTTÖÄ VARTEN.

Visuaalinen kieli



VAROITUS viittaa vaaratilanteeseen, joka voi – jos sitä ei vältetä – johtaa kuolemaan tai vakavaan loukkaantumiseen.



HUOMAUTUS viittaa lisätietoihin, joista on hyötyä tuotteen ongelmattoman ja optimaalisen käytön kannalta.



Silmämääräinen tarkistus - **kunnossa**



Silmämääräinen tarkistus **ei OK**



Kuultavissa oleva napsahdus

MIKILVÆGT - GEYMIÐ ÞESSAR LEIÐBEININGAR TIL SÍÐARI NOTA.

Tungumál



VIÐVÖRUN gefur til kynna hættulegar aðstæður sem geta valdið dauða eða alvarlegum meiðslum ef ekki er í komið í veg fyrir þær.



ATHUGIÐ gefur til kynna viðbótarupplýsingar sem koma að gagni við að tryggja hnökralausa og hagnýta notkun vörunnar.



Sjónræn skoðun - **í lagi**



Sjónræn skoðun, **ekki í lagi**



Smellur heyrst

OLULINE - ENNE KASUTAMIST LOE TÄHELEPANELIKULT LÄBI KASUTUSJUHENDID JA HOIA NEED ALLES EDASPIDISEKS.

Visuaalne keel



HOIATUS tähistab ohtlikku olukorda ja kui seda ei õnnestu vältida, võib see lõppeda surma või kehavigastusega.



MÄRKUS tähistab lisateavet, mida on vaja toote muretu ja optimaalse kasutamise jaoks.



Visuaalne kontroll **on läbitud**



Visuaalne kontroll **ei ole korras**



Kuuldav klõpsatus

SVARĪGI - PIRMS LIETOŠANAS UZMANĪGI IZLASIET ŠO INSTRUKCIJU.

Vizuālie apzīmējumi



BRĪDINĀJUMS norāda uz bīstamu situāciju, kas var izraisīt nāvi vai nopietnu traumu, ja tā netiek novērsta.



PIEZĪME sniedz papildinformāciju, kas ir noderīga netraucētai un optimālai produkta lietošanai.



Vizuālā pārbaude - **OK**



Vizuālā pārbaude - **Nav OK**



Dzirdams klikšķis

SVARBU - PRIEŠ NAUDOJANT ATIDŽIAI PERSKAIITYTI INSTRUKCIJAS IR IŠSAUGOTI JAS.

Matoma kalba



IŠPĒJIMAS nurodoma pavojīga situācija, kurios neišvengus galima žūti arba patirti rimtų sužeidimų.



PASTABA nurodoma papildoma informacija, naudinga norint gaminį eksploatuoti be problemų ir optimaliai naudoti.



Vizualinė patikra - **teisinga**



Vizualinis patikrinimas - **neteisingas**



Spragtelėjimas

ВАЖЛИВО - ЗБЕРІГАЙТЕ ЦІ ІНСТРУКЦІЇ ДЛЯ ПОДАЛЬШОЇ ДОВІДКИ.

Мова візуального спілкування



ПОПЕРЕДЖЕННЯ вказує на небезпечну ситуацію, яка, якщо її не уникнути, може призвести до смерті або серйозних травм.



ПРИМІТКА вказує на додаткову інформацію, корисну для безперебійного та оптимального використання виробу.



Візуальний огляд - **добре**



Візуальний огляд - **не пройшла**



Чутне клацання

WAŻNE - PRZED UŻYTKOWANIEM
DOKŁADNIE PRZECZYTAĆ
NINIEJSZĄ INSTRUKCJĘ I
ZACHOWAĆ JĄ NA PRZYSZŁOŚĆ.

Piktogramy



OSTRZEŻENIE wskazuje potencjalnie niebezpieczną sytuację, która może, jeśli się jej nie uniknie, spowodować poważne obrażenia lub nawet śmierć.



UWAGA oznacza dodatkowe informacje, z których warto korzystać, aby bezproblemowo i optymalnie użytkować produkt.



Sprawdzenie wizualne — **OK**



Sprawdzenie wizualne — **Nie OK**



Słyszalne kliknięcie

DŮLEŽITÉ - PŘED POUŽITÍM SI
PŘEČTĚTE POZORNĚ NÁVOD
A USCHOVEJTE PRO POZDĚJŠÍ
NAHLÉDNUTÍ.

Vizuální jazyk



VAROVÁNÍ značí nebezpečnou situaci, která může, pokud se jí nevyhnete, vést ke smrti nebo vážnému zranění.



POZNÁMKA značí dodatečné informace, které jsou užitečné pro bezproblémové a optimální používání produktu.



Vizuální kontrola **OK**



Vizuální kontrola **Není OK**



Hlasité zaklapnutí

FONTOS - HASZNÁLAT ELŐTT
FIGYELMESEN OLVASSA EL AZ
UTASÍTÁSOKAT ÉS ŐRIZZE MEG A
JÖVŐBENI HIVATKOZÁSHOZ.

Vizuális jelzések



FIGYELMEZTETÉS olyan veszélyes helyzetet jelez, amely, ha nem kerülök el, halálhoz vagy súlyos sérüléshez vezethet.



MEGJEGYZÉS a termék problémamentes és optimális használatához hasznos kiegészítő információkat jelöl.



A vizuális ellenőrzés — **OK**



A vizuális ellenőrzés — **nem OK**



Hallható kattanás

IMPORTANT - PĂSTRAȚI ACESTE
INSTRUCȚIUNI PENTRU CONSUL-
TARE ULTERIOARĂ.

Limbajul vizual



AVERTISMENT indică o situație periculoasă care, dacă nu este evitată, poate provoca răniiri grave sau deces.



NOTĂ indică informații suplimentare, care sunt folosite pentru utilizarea fără probleme și optimă a produsului.



Inspecție vizuală — **OK**



Inspecție vizuală — **Nu OK**



Sunet de clic audibil

DÔLEŽITÉ - PRED POUŽITÍM
PREČÍTAJTE POZORNE TENTO
NÁVOD A USCHOVAJTE HO PRE
BUDÚCU POTREBU.

Vizuálny jazyk



VAROVANIE označuje
nebezpečnú situáciu, ktorá
môže mať za následok smrť
alebo vážne zranenie, ak sa jej
nezabráni.



POZNÁMKA označuje
dodatčné informácie, ktoré sú
užitočné pre bezproblémové
a optimálne používanie výrobku.



Vizuálna kontrola - **dobrá**



Vizuálna kontrola - **zlá**



Počuteľné kliknutie

POMEMBNO - PRED UPORABO
POZORNO PREBERITE NAVODILA
IN JIH SHRANITE KOT NAPOTEK
ZA V PRIHODNJE.

Oznake



OPOZORILO označuje nevarno
situacijo, ki lahko povzroči smrt
ali hude poškodbe, če se ji ne
izognete.



OPOMBA označuje dodatne
informacije, ki so koristne za
nemoteno in optimalno uporabo
izdelka.



Vizualna kontrola - **v redu**



Vizualna kontrola - **ni v redu**



Slišen klik

ВАЖНО - ЗАПАЗЕТЕ ТЕЗИ
ИНСТРУКЦИИ ЗА БЪДЕЩИ
СПРАВКИ.

Визуален език



ПРЕДУПРЕЖДЕНИЕ показва
опасна ситуация, която, ако
не бъде избегната, може да
доведе до смърт или сериозно
нараняване.



ЗАБЕЛЕЖКА показва
допълнителна информация, която
е полезна за безпроблемно
и оптимално използване на
продукта.



Визуалната проверка -
правилна



Визуалната проверка
- **неправилна**



Звуково щракване

VAŽNO - SAČUVAJTE OVE UPUTE
ZA BUDUĆU UPORABU.

Vizualan jezik



UPOZORENJE označava
opasnu situaciju koja, ako se ne
izbjegne, može uzrokovati smrt
ili ozbiljnu povredu.



NAPOMENA naznačuje dodatne
informacije korisne za neo-
metanu i optimalnu upotrebu
proizvoda.



Vizualna provjera - **OK**



Vizualna provjera - **Nije OK**



Zvučni klik

ΣΗΜΑΝΤΙΚΟ - ΦΥΛΑΞΤΕ ΑΥΤΕΣ ΤΙΣ ΟΔΗΓΙΕΣ ΓΙΑ ΜΕΛΛΟΝΤΙΚΗ ΑΝΑΦΟΡΑ.

Οπτική γλώσσα



ΠΡΟΕΙΔΟΠΟΙΗΣΗ υποδεικνύει επικίνδυνη κατάσταση η οποία, εάν δεν αποφευχθεί, ενδέχεται να καταλήξει σε θάνατο ή επικίνδυνο τραυματισμό.



ΣΗΜΕΙΩΣΗ υποδεικνύει επιπλέον πληροφορίες οι οποίες είναι χρήσιμες για την απρόσκοπτη και βέλτιστη χρήση του προϊόντος.



Οπτικός έλεγχος - **εντάξει**



Οπτικός έλεγχος - **σφάλμα**



Ηχητικό κλικ

ÖNEMLİ - BU TALİMATLARI İL-ERİDE BAŞVURMAK ÜZERE SAKLAYIN.

Görsel dil



UYARI, kaçınılmadığı takdirde ölüm veya ciddi yaralanmayla sonuçlanabilecek tehlikeli bir durumu belirtir.



NOT, ürünün sorunsuz ve en uygun kullanımı için yararlı olan ek bilgileri gösterir.



Görsel kontrol - **doğru**



Görsel kontrol - **hatalı**



Tıklama sesi

هام - احتفظ بهذه الإرشادات للرجوع إليها في المستقبل.

اللغة المرئية



تحذير يشير إلى موقف خطير قد يؤدي، عند عدم تجنبه، إلى الموت أو حدوث إصابة خطيرة.



ملاحظة تشير إلى معلومات إضافية مفيدة من أجل استخدام مثالي للمنتج خالٍ من المشاكل.



الفحص البصري - جيد



الفحص البصري - خاطئ



نقرة مسموعة

חשוב - קרא בקפידה ושמור לעיון במועד מאוחר יותר.

שפה ויזואלית



אזהרה מציינת מצב מסוכן שאם לא נמנע ממנו עלול לגרום למוות או לפציעה חמורה.



הערה מציינת מידע נוסף המועיל לשימוש אופטימלי וללא תקלות של המוצר.



בדיקה חזותית בסדר



בדיקה חזותית לא בסדר



לחיצה שנשמעת

IMPORTANTI - AQRA BIR-REQQA U ŻOMM GĦAL REFERENZA FIL-FUTUR.

Lingwa viżwali



TWISSIJA tirraġuna situazzjoni perikoluża li, jekk mhix tintlaħaq, tista' twassal għall-mewt jew l-inġurja serja.



NOTA tindika informazzjoni addizzjonali li hija utli biex tagħmel l-aħjar użu, bla problemi, tal-prodott.



Il-verifika **viżwali tajba**



Il-verifika **viżwali ħażina**



Hoss li jinstema'

ZH-SC

重要提示 - 请仔细阅读并保留供日后参考

图示



警告表示危险情况, 如果不避免, 可能会导致死亡或严重伤害。



注意表示有助于无故障和最佳使用产品的附加信息。



目视检查通过



目视检查出错



听到“咔嗒”声

重要 - 請仔細閱讀並保管此說明，以便未來參考使用。

視覺語言



警告表示危險情況，如果不避免，可能會導致死亡或嚴重傷害。



注意表示有助於無故障和最佳使用產品的附加信息。



目測檢查通過



目測檢查錯誤



有聲點擊

JP

重要 - 注意深くお読みいただき、今後も参照できるよう保管してください。

ビジュアル言語



警告は、回避しないと死亡または重傷を負う可能性がある危険な状況を示します。



注は、製品をトラブルなく最適に使用するために役立つ追加情報を示します



目で見て確認できます



目視確認の結果が異常です



カチッと音がします

중요 - 나중에 참고할 수 있도록 이 지침을 잘 보관하십시오.

시각 언어



경고는 피하지 않을 경우 사망이나 심각한 부상을 초래할 수 있는 위험한 상황을 나타냅니다.



참고는 제품을 문제 없이 최적으로 사용하는 데 유용한 추가 정보를 나타냅니다



육안 검사 결과가 양호합니다



육안 검사 결과에 문제가 있습니다



찰칵 소리가 들립니다

PENTING - BACA DENGAN TELITI DAN SIMPAN UNTUK RUJUKAN MASA HADAPAN.

Bahasa visual



AMARAN menunjukkan keadaan berbahaya yang, jika tidak dielakkan, boleh mengakibatkan kematian atau kecederaan serius.



NOTA menunjukkan maklumat tambahan yang berguna untuk penggunaan produk yang bebas masalah dan optimum.



Pemeriksaan visual **OK**



Pemeriksaan visual **Tidak OK**



Klik boleh dengar

สำคัญ - อ่านอย่างละเอียด และเก็บไว้เพื่อใช้อ้างอิงใน

ภาษาภาพ



คำเตือน บ่งชี้ถึงสถานการณ์อันตรายซึ่งหากไม่หลีกเลี่ยง อาจส่งผลให้เสียชีวิตหรือบาดเจ็บสาหัสได้



หมายเหตุ ระบุข้อมูลเพิ่มเติมที่เป็นประโยชน์สำหรับการใช้ผลิตภัณฑ์อย่างไร้ปัญหาและเหมาะสมที่สุด



ตรวจดูด้วยสายตาแล้วเป็นปกติ



ตรวจดูด้วยสายตาแล้วผิดปกติ



ได้ยินเสียงเข้าล็อค

EN	LV
Towbar mounted bike carrier	Uz piekabes āķa uzstādāms velosipēdu turētājs
FR	LT
Porte-vélos sur boule d'attelage	Prie gražūlo tvirtinami dviračių laikikliai
ES	RU
Portabicicletas de bola de remolque	Устанавливаемое на фаркопе крепление для велосипедов
DE	UK
Fahrradträger für die Anhängerkupplung	Складний вантажний ящик на фаркопі
NL	PL
Fietsdrager voor op de trekhaak	Bagażnik rowerowy montowany na haku holowniczym
PT	CS
Suporte para bicicleta para engate	Nosič jízdních kol s montáží na tažné zařízení
IT	HU
Portabici da installare sul gancio da traino	Vonóhorogra szerelhető kerékpártartó
SV	RO
Dragkroksmonterad cykelhållare	Suport pentru bicicletă montat pe bara de tracțiune
DA	SK
Cykelholder, der er monteret på anhængertræk	Nosič bicyklov s montážou na ťažné zariadenie
NO	SL
Hengerfestemonterte lasteholdere	Prtljažnik za kolesa za na vlečno kljuko
FI	BG
Vetokoukkuun kiinnitettävä polkupyöräteline	Багажник за велосипеди, монтиран на теглича
IS	
Hjólagrind á dráttarkúlu	
ET	
Haakekonksule paigaldatav jalgrattahoidik	

HR

Nosač bicikla koji se postavlja na kuku za vuču

EL

Σχάρα ποδηλάτου κοτασδόρου

TR

Çeki demirine bağlanan bisiklet taşıyıcı

MT

Pembawa basikal yang dipasang pada bar tunda

HE

הרמה או לע בכחמה מיינפוא אשנמ

AR

رطقول بيضرقى لع ع بيكرت لل ةج اردلا لمح

SC

拖杆安装式托架

TR

拖桿式自行車架

JA

トウバーマウント型サイクルキャリア

KO

토우바 장착 자전거 캐리어

TH

ครงยึดจับจักรยานแบบติดตั้งกับอุปกรณ์ลากพ่วงท้ายรถ

MS

Ġarrier tar-roti immuntat b'virga għall-irmonkar



THULE

Instructions



THULE

Safety

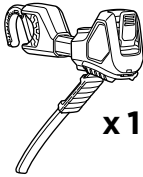

x1

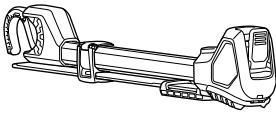

x1



x2



x2



x2



x2

5 mm

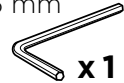

x1

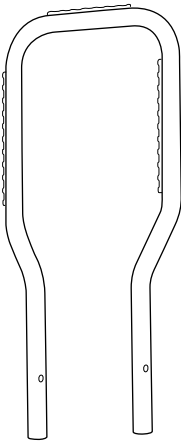

x1

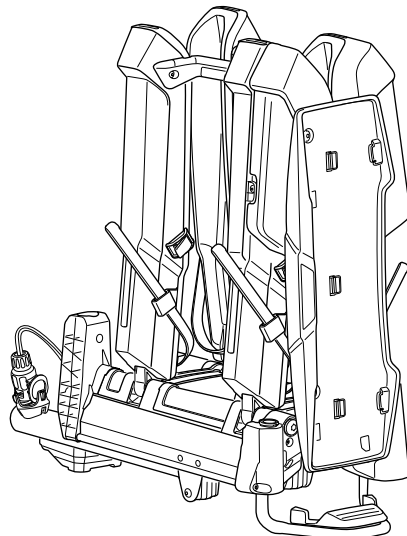

x1

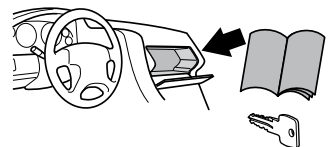
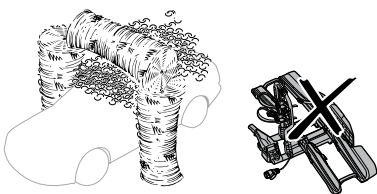
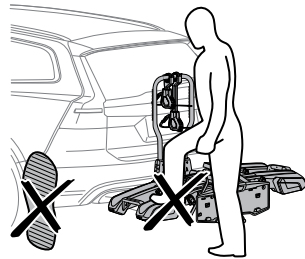
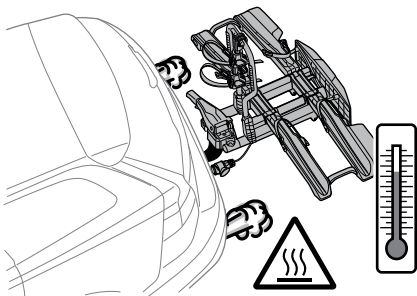
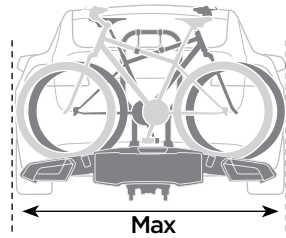
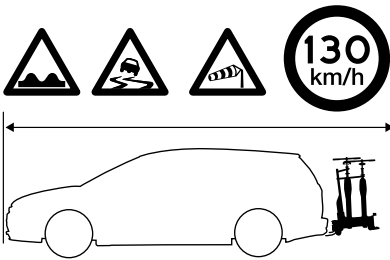
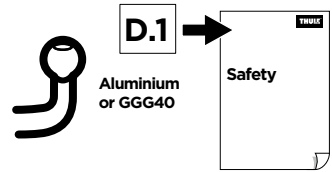
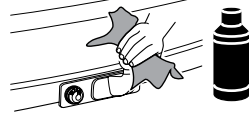
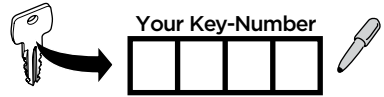
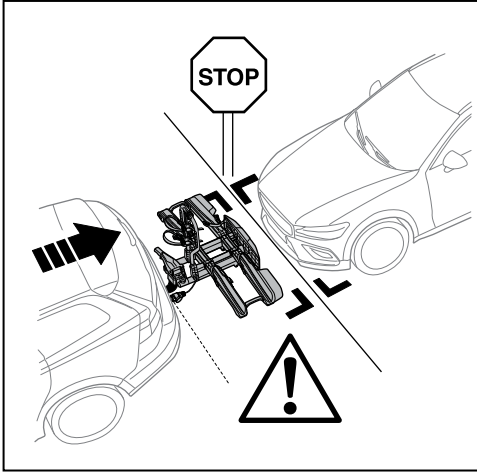

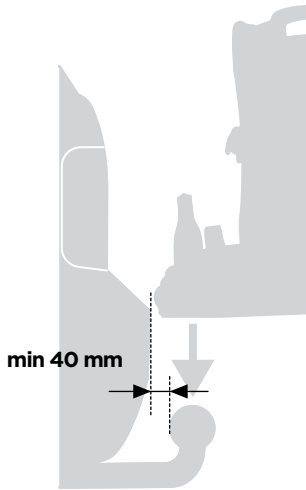

min 40 mm

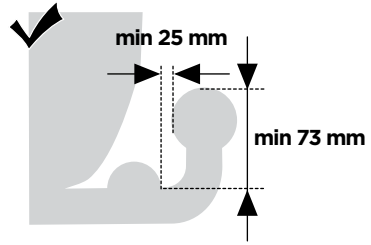

min 25 mm

min 73 mm

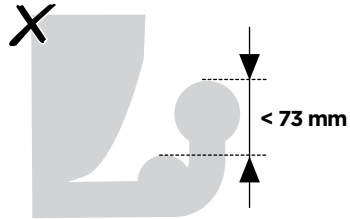

< 73 mm

i

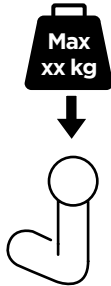

40 kg

50 kg

60 kg

70 kg

80 kg

90 kg



18,2 kg

Max 21,8 kg

Max 31,8 kg

Max 41,8 kg

Max 51,8 kg

Max 60 kg

Max 60 kg

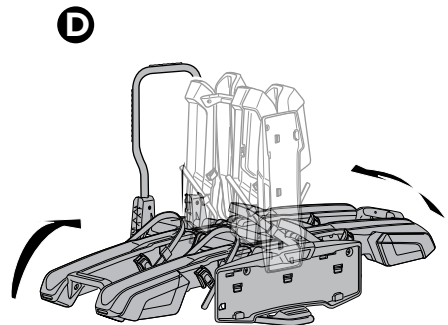
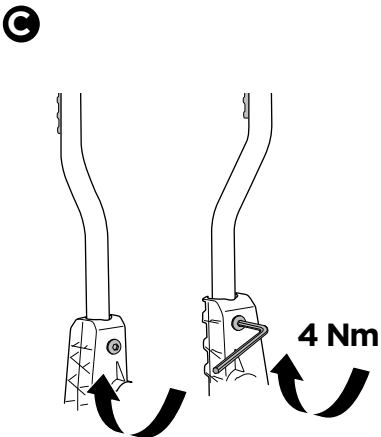
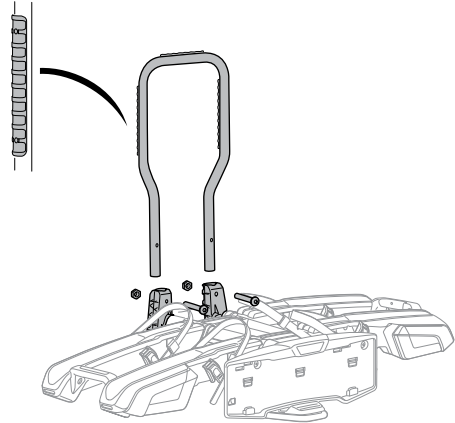
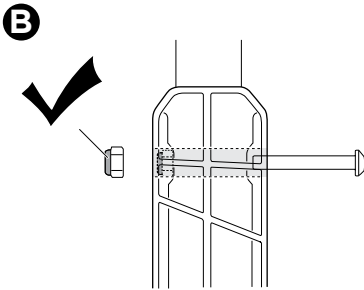
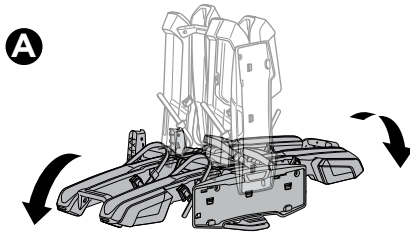
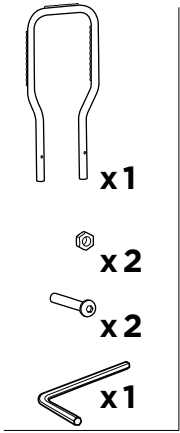

2

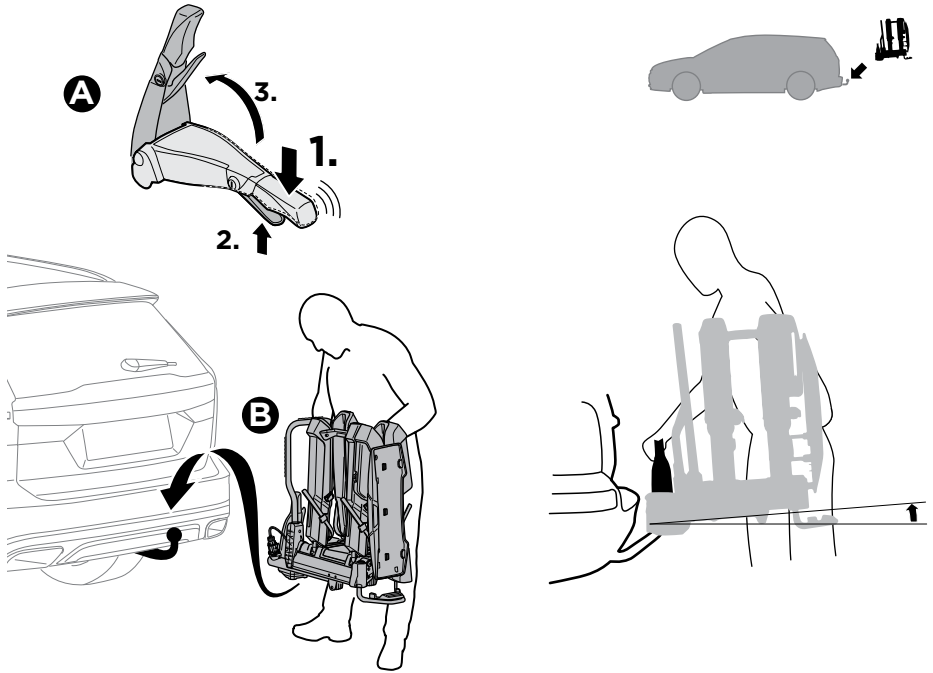

i

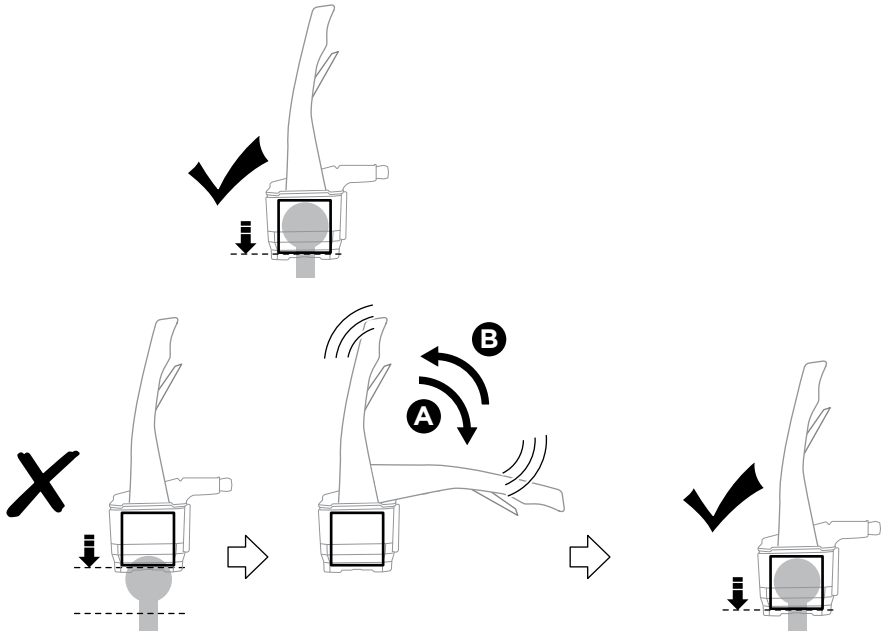

3

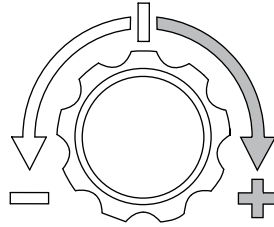
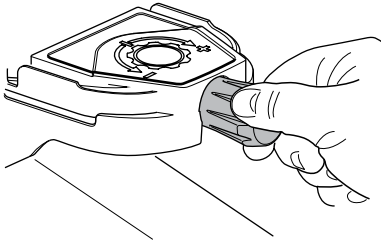
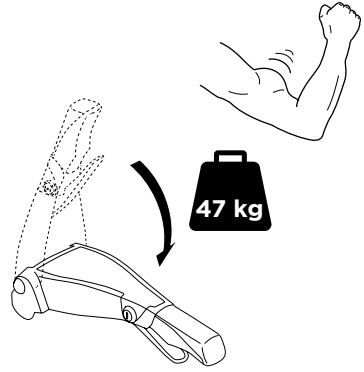
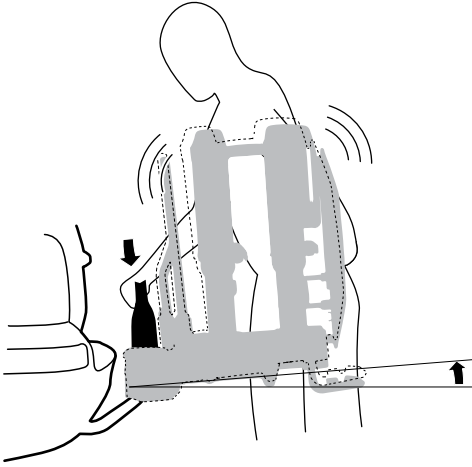

4

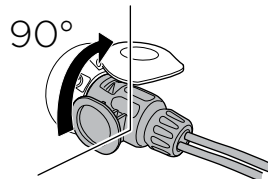
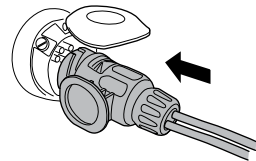
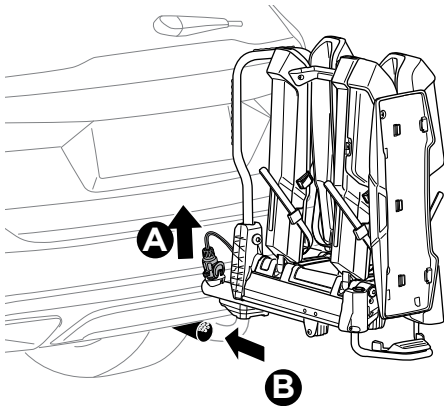

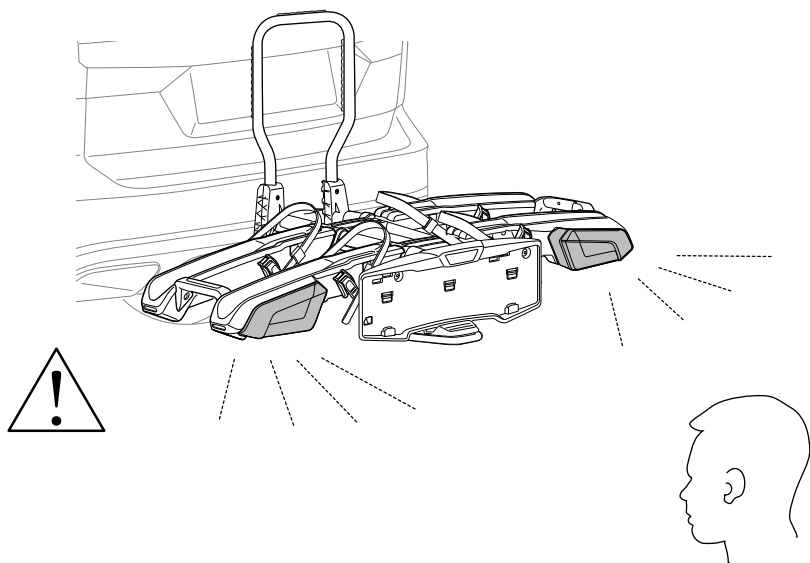
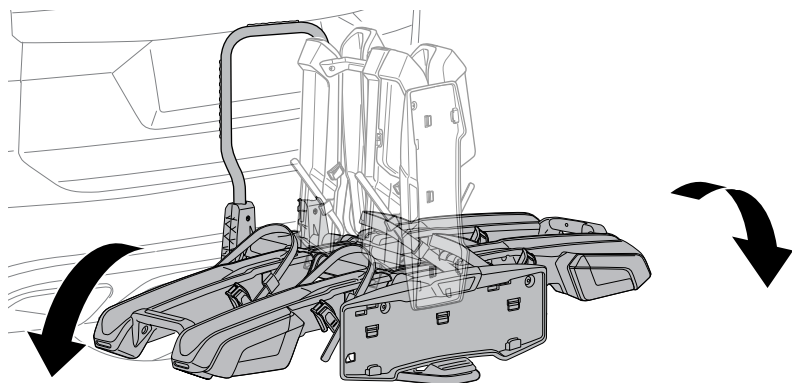

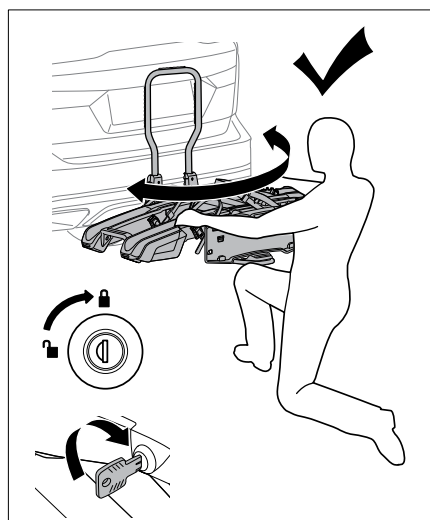
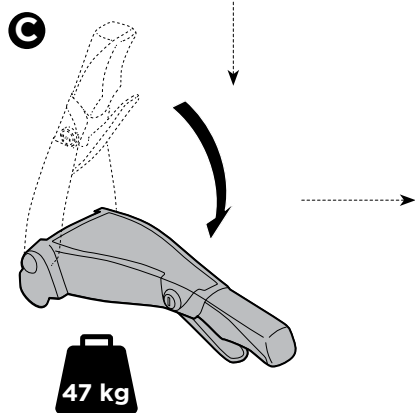
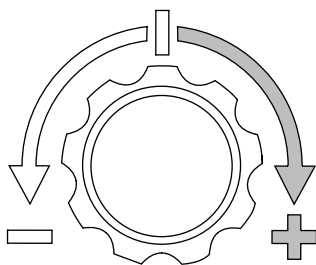
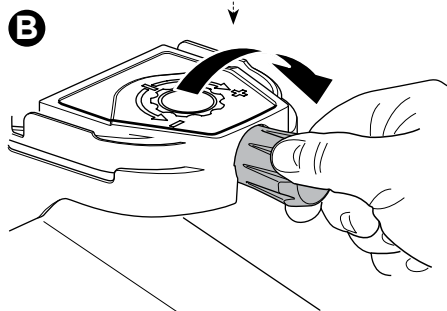
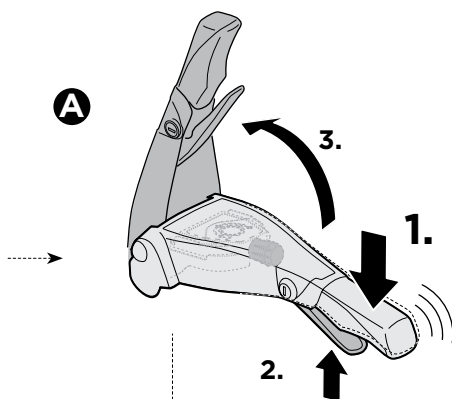
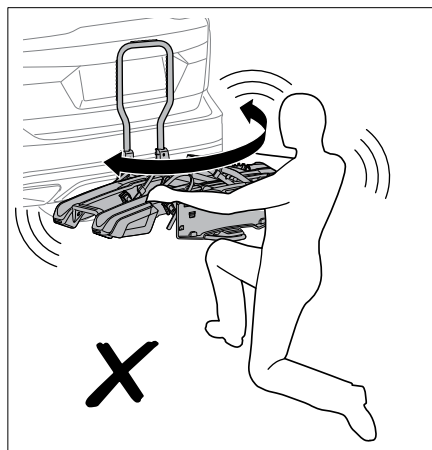

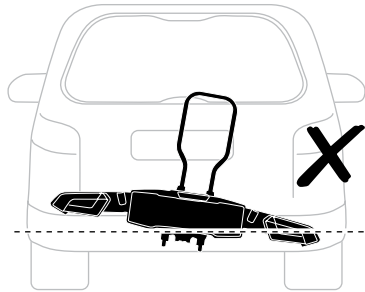
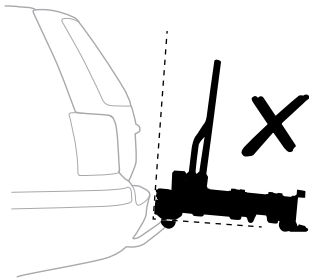
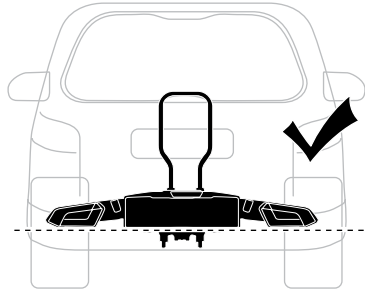
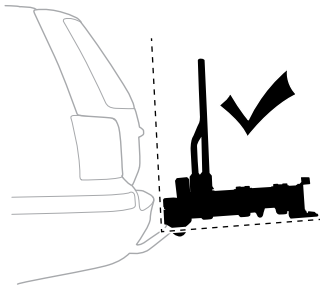

7

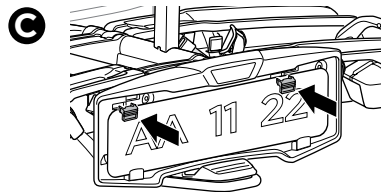
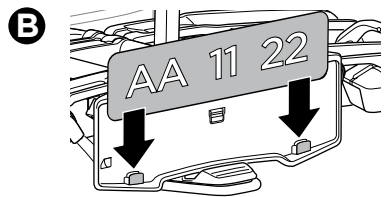
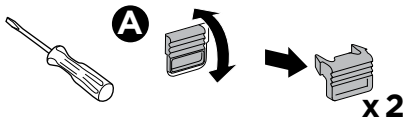
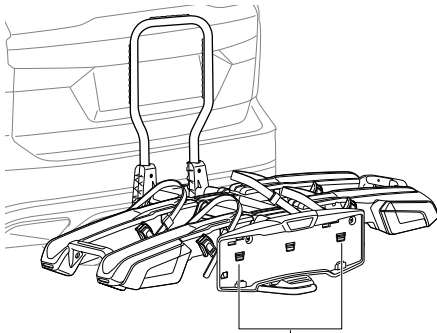

8

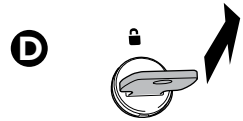
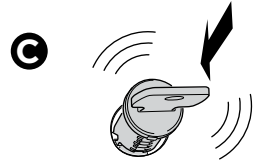
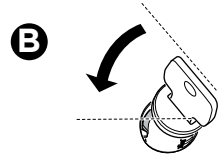
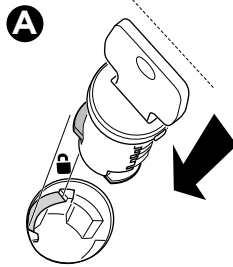
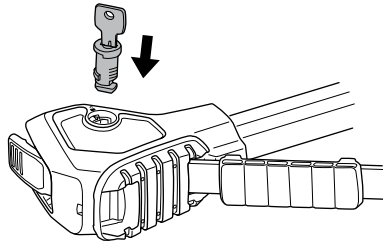
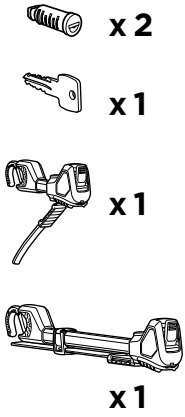

i

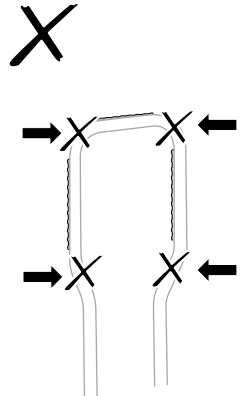
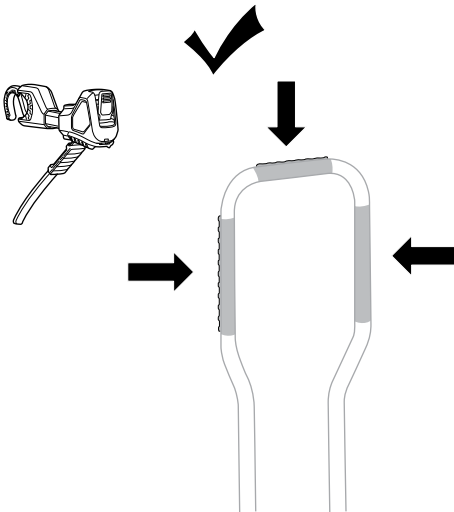

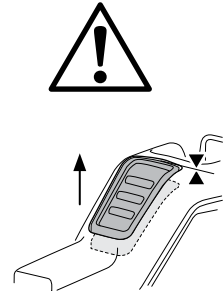
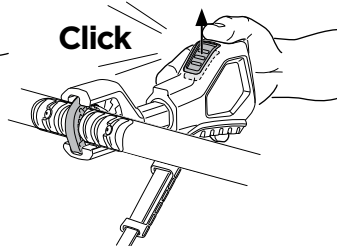
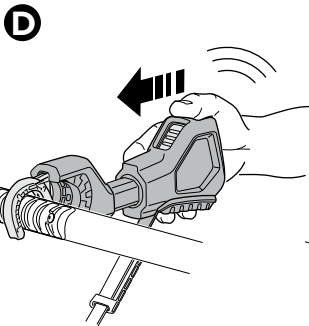
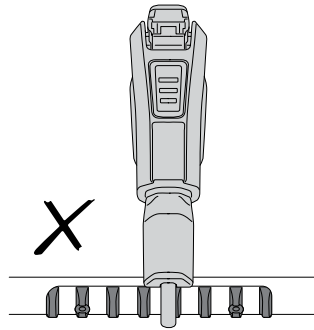
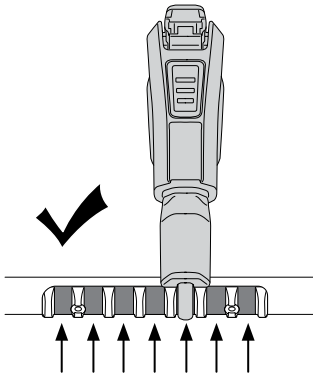
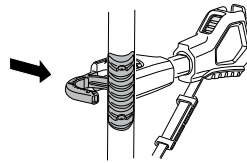
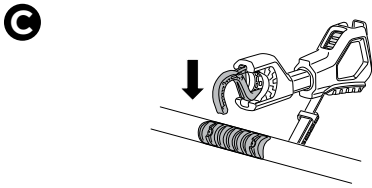
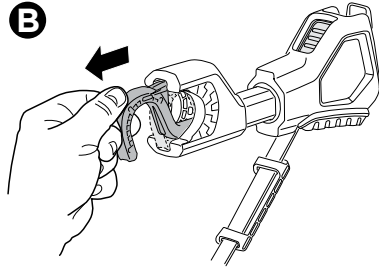
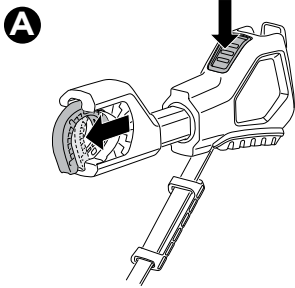

i

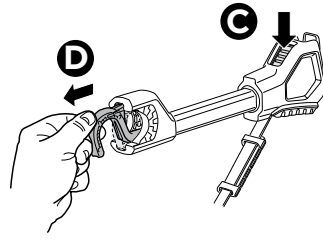
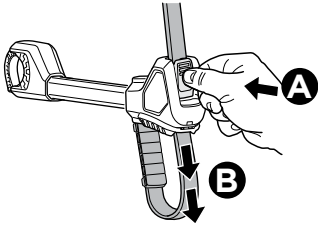

i

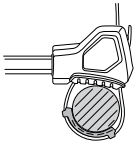
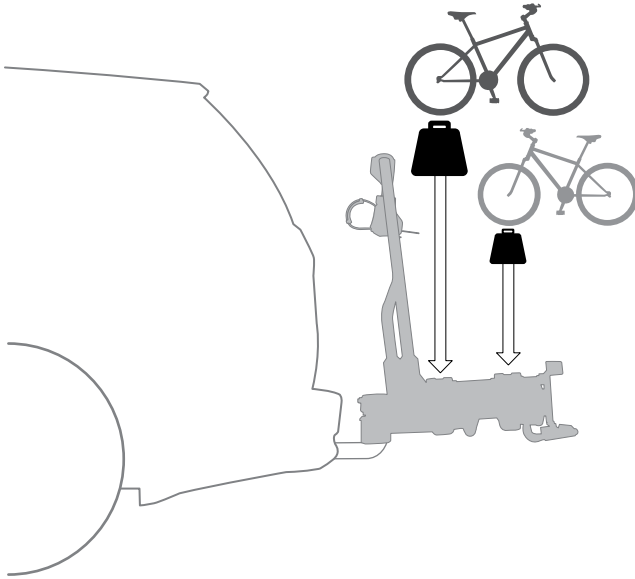

20-90mm

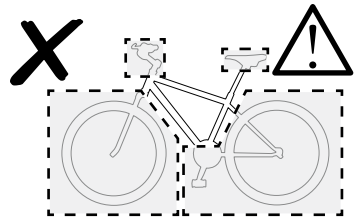
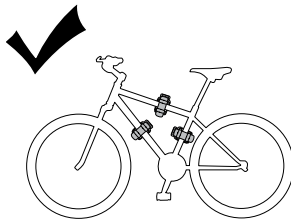
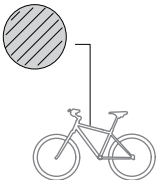

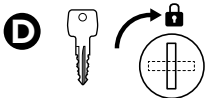
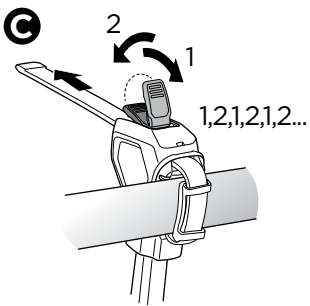
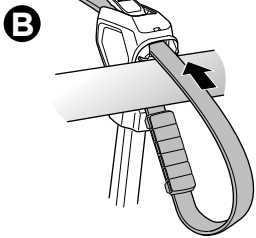
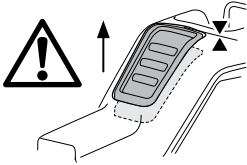
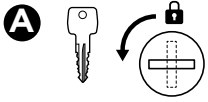

1 (2)

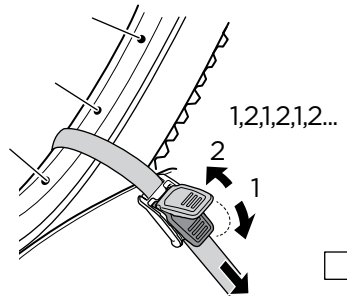
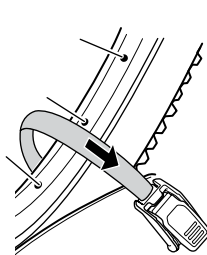
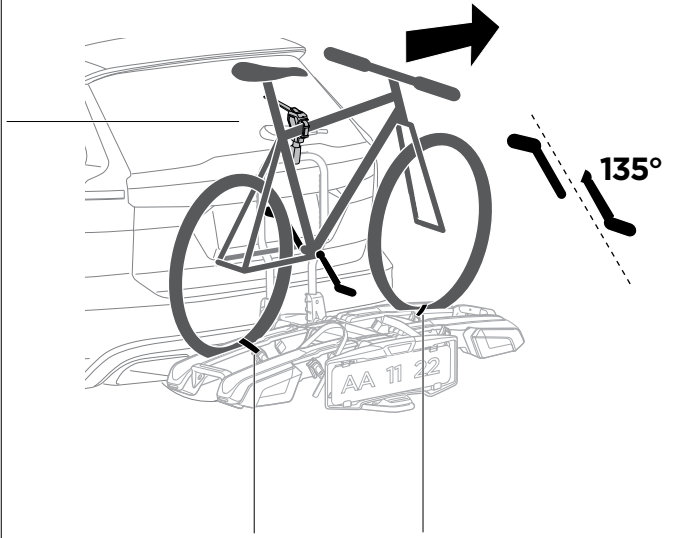
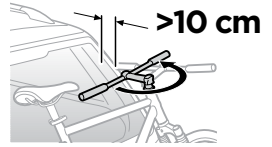
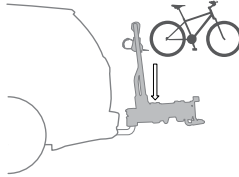

10

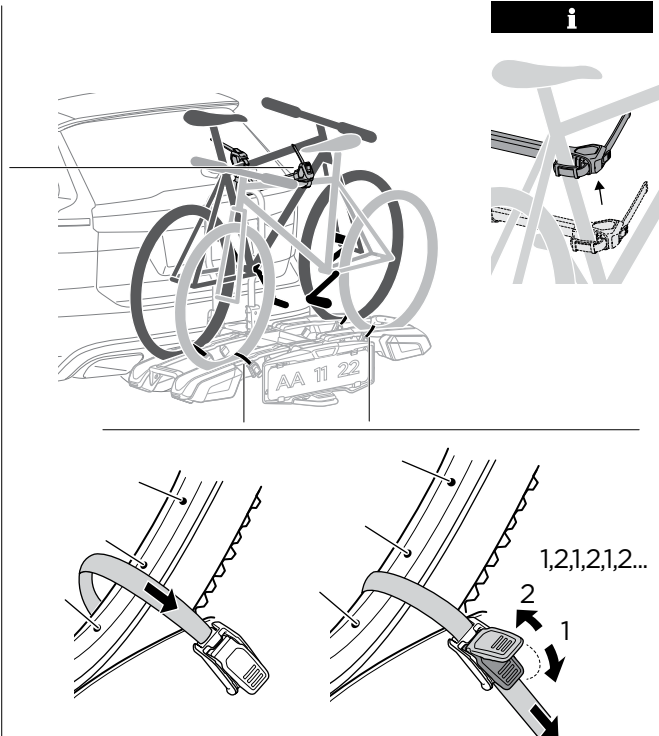
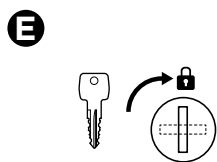
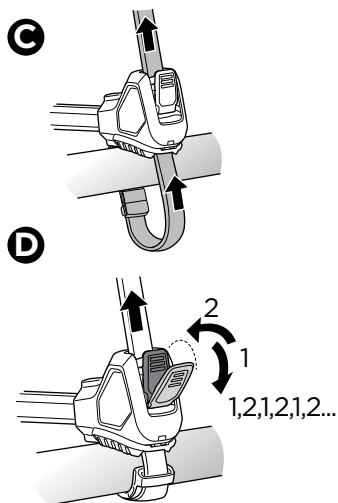
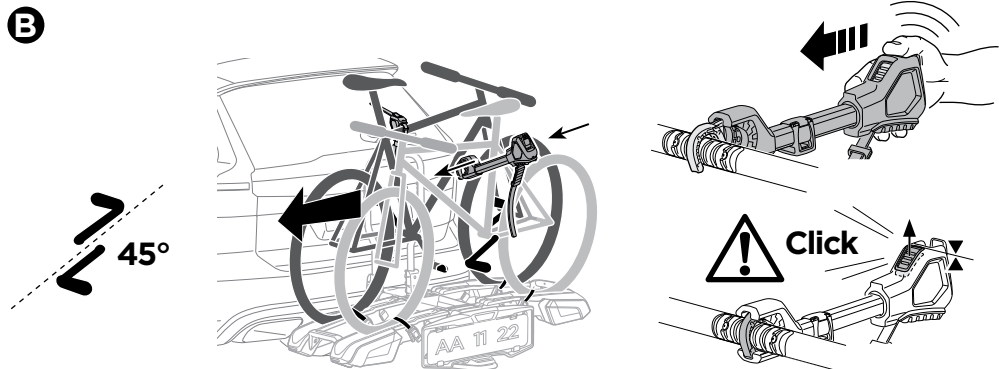
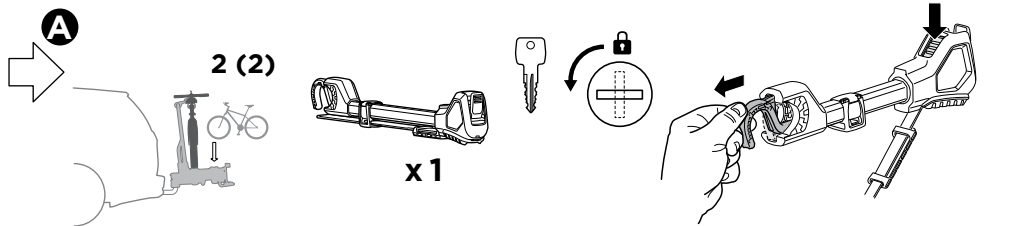

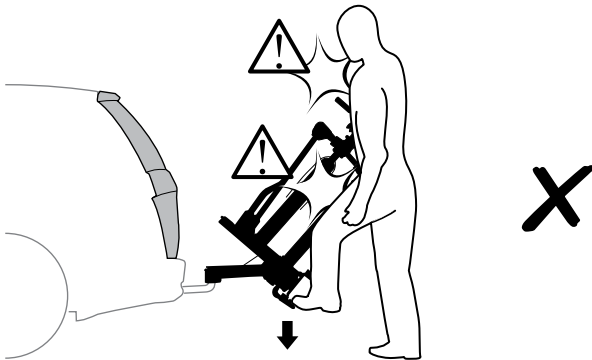
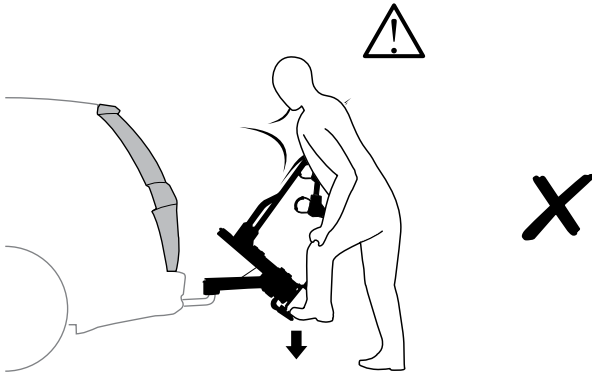
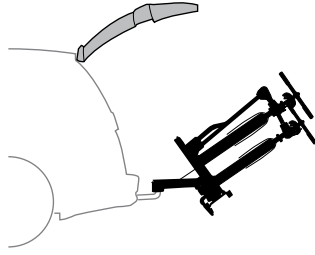
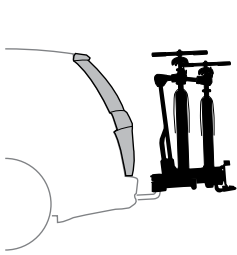

11

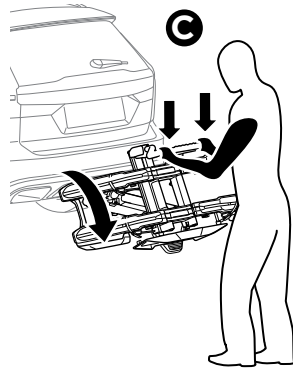
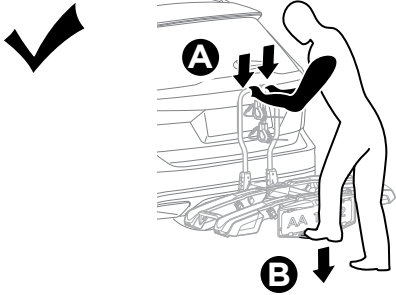
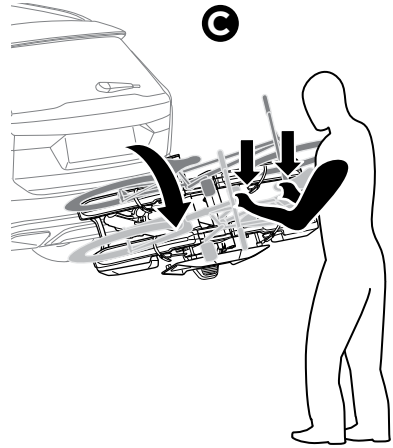
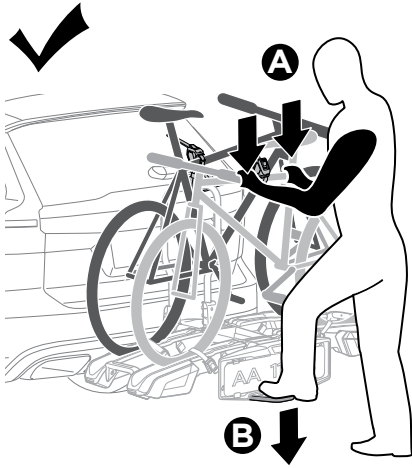

12

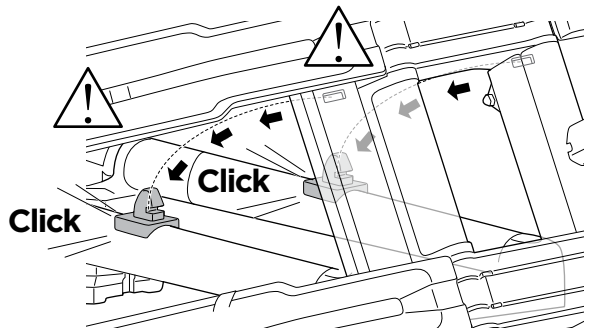
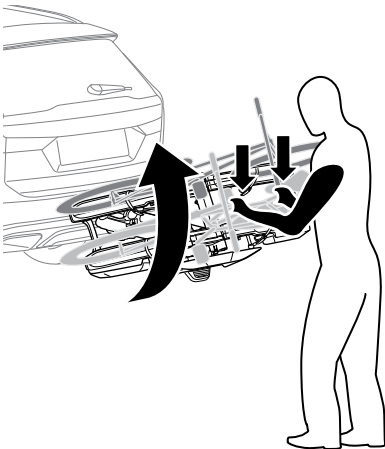

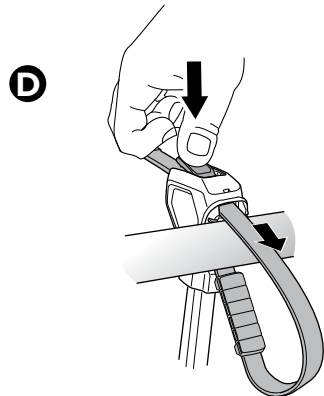
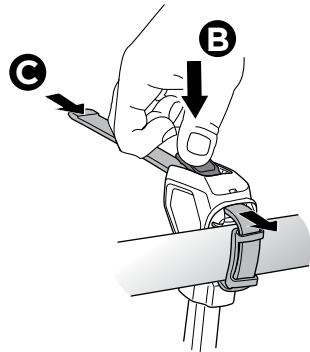
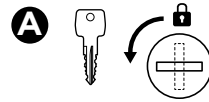
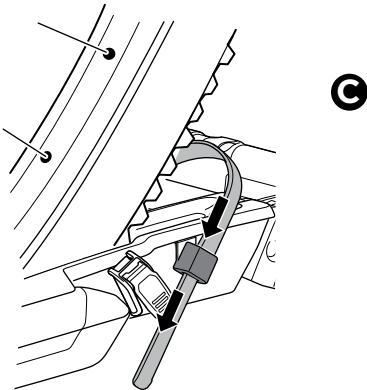
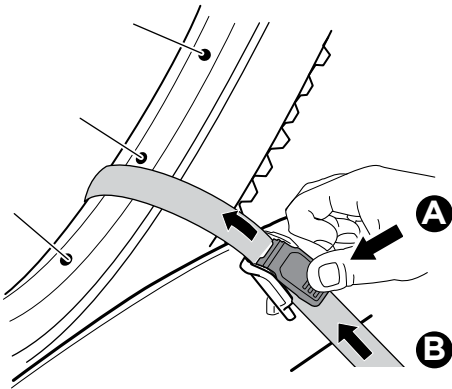
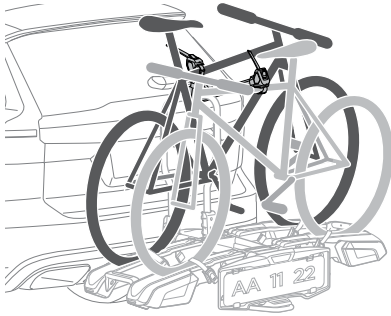

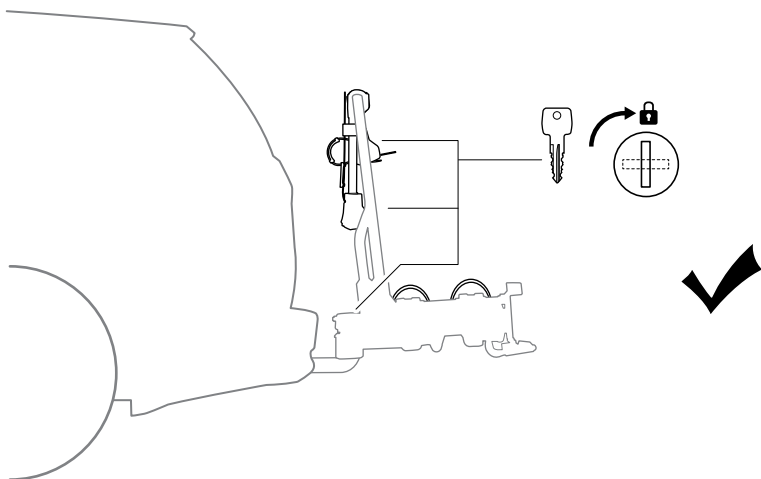
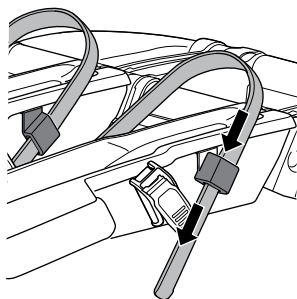
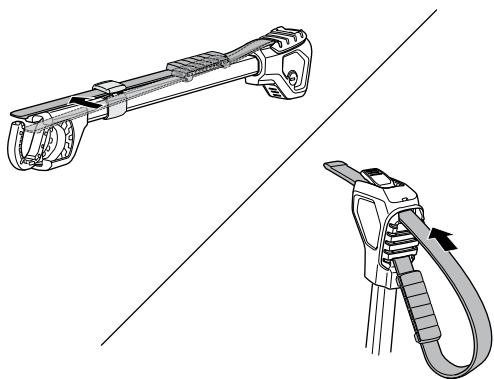
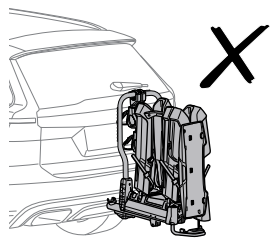
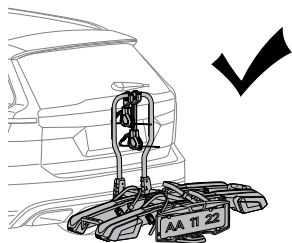
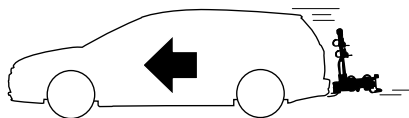

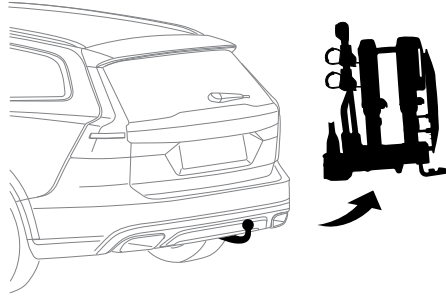

A

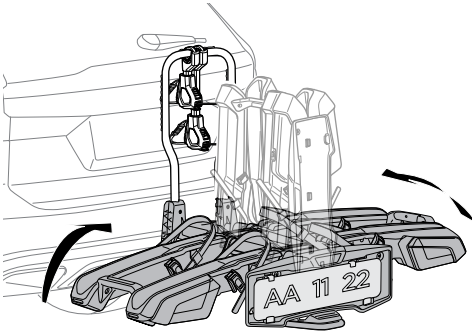

C

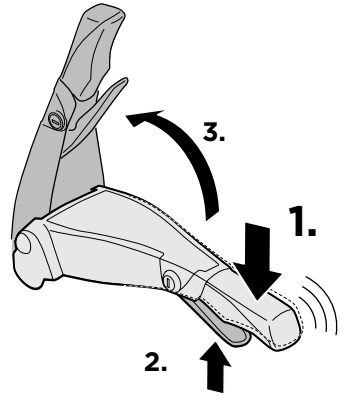

B

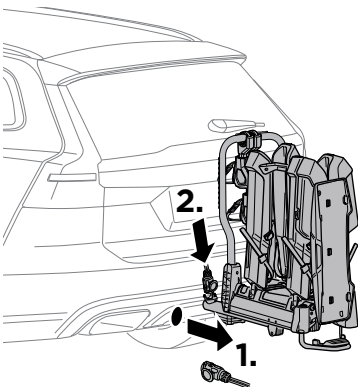

D

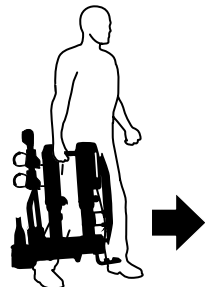
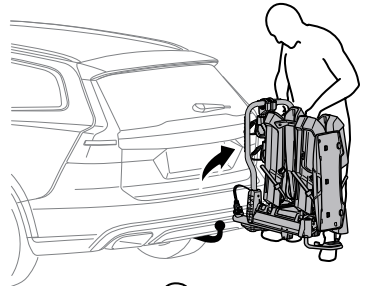

Spare parts

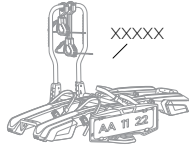

→ [Thule.com](https://www.thule.com)

EN Spare parts
FR Pièces de rechange
ES Repuestos
DE Ersatzteile
NL Onderdelen
PT Peças de reposição
IT Pezzi di ricambio
SV Reservdelar
DK Reservedeler
NO Reservedeler
FI Varaosat
IS Varahlutir

ET Varuosad
LV Rezerves daļas
LT Atsarginės dalys
RU Запчасти
UK Запасні частини
PL Części zamienne
CS Náhradní díly
HU Alkatrészek
RO Piese de schimb
SK Náhradné diely
SL Nadomestni deli
BG Резервни части

HR Rezervni dijelovi
EL Ανταλλακτικά
TR Yedek parçalar
MT Partijiet tal-bdil

תלקי חילוף **HE**
 قطع غيار **AR**

ZH-CN 备件
ZH-TR 備件
JA 予備部品
KO 예비 부품
TH ๑๕๖๓
MS Alat ganti

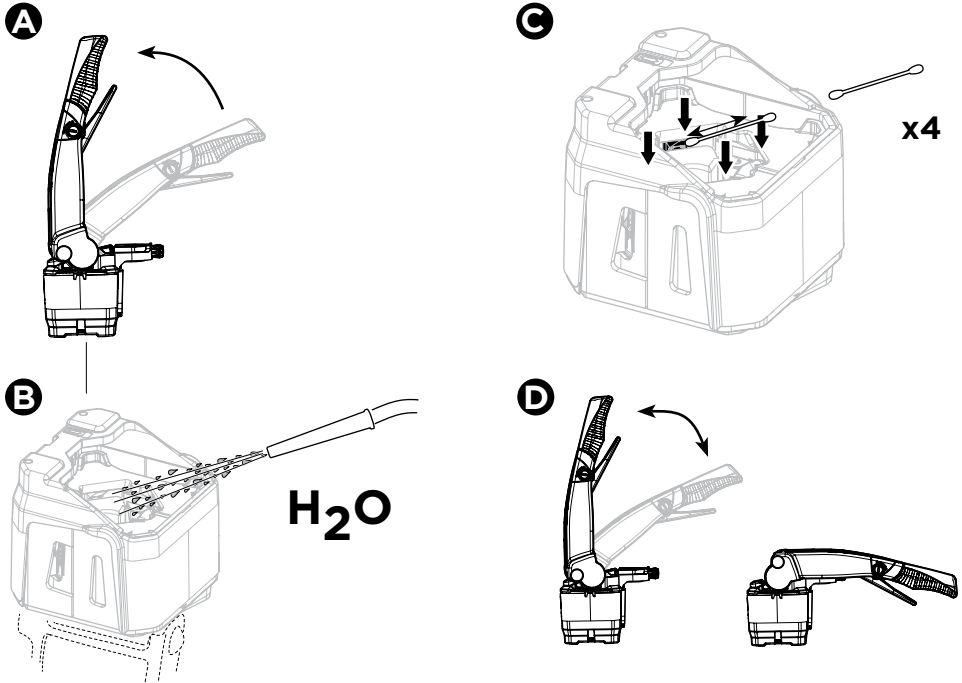

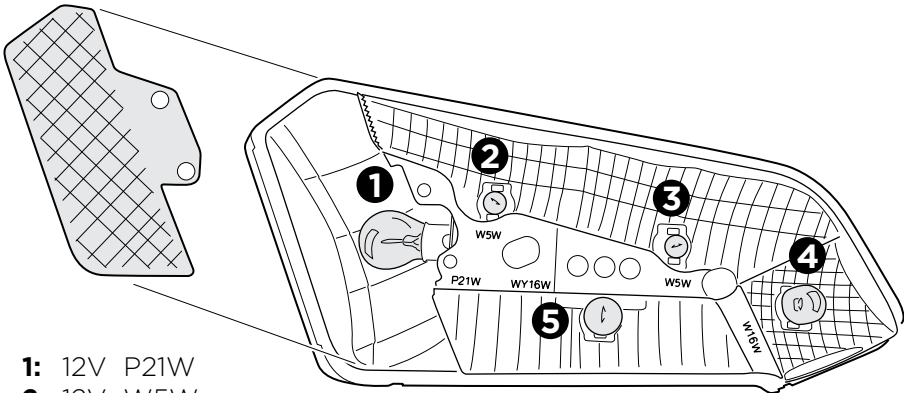
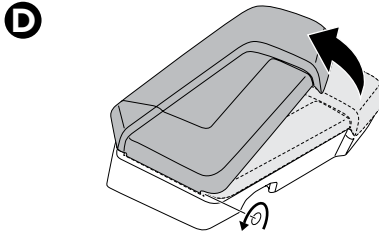
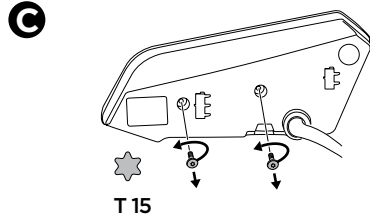
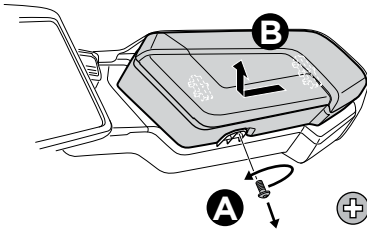
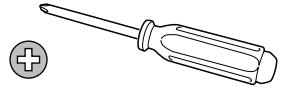
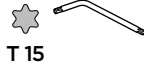

- 1: 12V P21W
- 2: 12V W5W
- 3: 12V W5W
- 4: 12V W16W
- 5: 12V WY16W

Accessories

EN Accessories
FR Accessoires
ES Accesorios
DE Zubehör
NL Accessoires
PT Acessórios
IT Accessori
SV Tillbehör
DK Tilbehør
NO Tilbehør
FI Lisävarusteet
IS Aukabúnaður

ET Tarvikud
LV Piederumi
LT Priedai
RU Аксессуары
UK Аксесуари
PL Akcesoria
CS Příslušenství
HU Kiegészítők
RO Accesorii
SK Príslušenstvo
SL Dodatki
BG Аксесоари

HR Dodaci
EL Αξεσουάρια
TR Aksesuarlar
MT Aċċessorji

אביזרים **HE**
 الملحقات **AR**

ZH-CN 附件
ZH-TR 配件
JA アクセサリー
KO 액세서리
TH อุปกรณ์เสริม
MS Aksesori

Thule EasyFold 3 Storage Bag 2 bike 9446

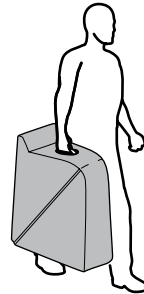
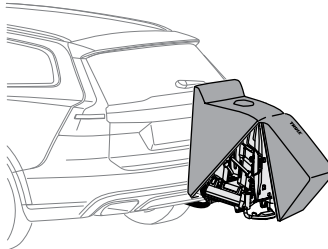
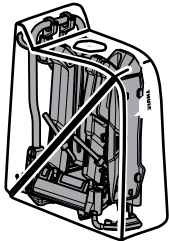

Thule EasyFold 3 Foldable Bike Add-on (Bike Adapter) 9447

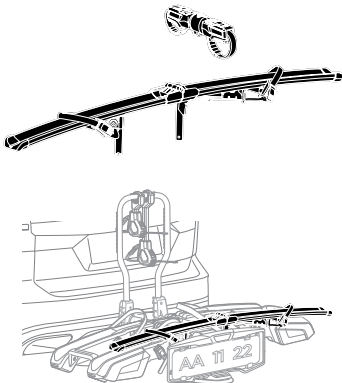

Thule High-Grade Lock 9785

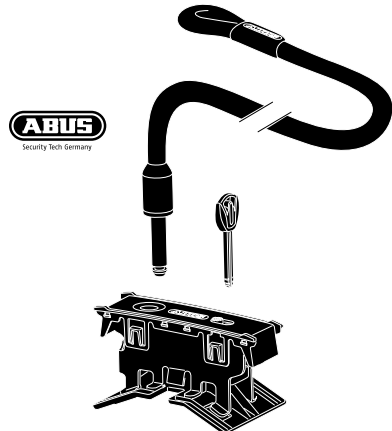

Thule Santu

9094

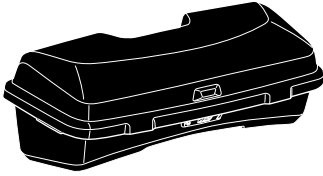

Thule Onto 2

9092

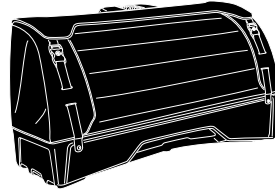

Thule Foldable Loading Ramp

9787

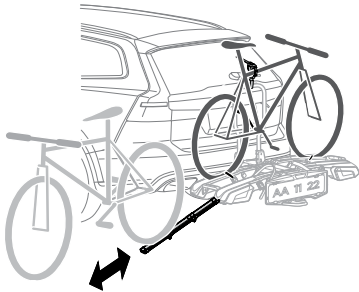
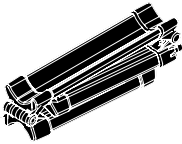

Thule Road Bike Adapter

9772



Thule Extra Long Wheel Straps

985

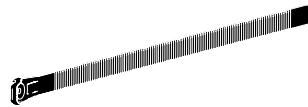

Thule Adapter 9906

7-to-13-pin

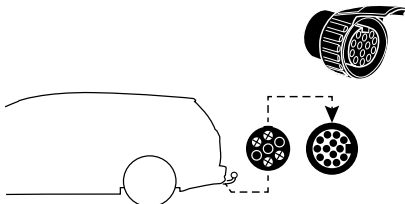

Thule 3rd Brake Light

9904

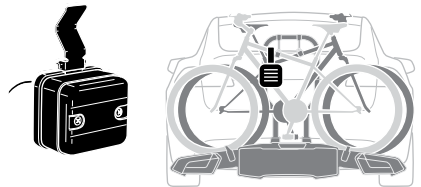

Thule Sweden AB

Borggatan 5, 335 73 Hillerstorp, SWE
info@thule.com | www.thule.com

© Thule Group. All rights reserved.
5563642001 | 2024-09-30 #01

» PART OF THULE GROUP